

# USER MANUAL



Thank you for choosing Better Bathrooms.  
Please read this manual before installing your product  
and keep for future reference

better  
bathrooms

**Product name - 4-Hole Deck Mounted Bath Shower Mixer**  
**Product code - BeBa\_27752**

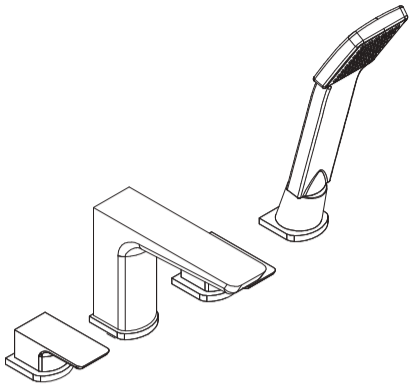

- Single-person assembly
- We always recommend using professional tradespeople to install your product

V2\_07.12.2021

## Congratulations on your purchase

And welcome to our growing gang of savvy shoppers

We're on a mission to bring you extraordinary bathroom products, for less. From modern to traditional style ceramics, plus the gorgeous fixtures, fittings and furniture to match. So, you can fall in love with your space every single day.

As one of the UK's largest independent bathroom stores, we've received countless awards; including the National Business Awards UK, the Digital Entrepreneur Awards and being placed on The Sunday Times Fast Track 100.

We hope your new product exceeds your highest expectations. However, if you experience any problems, please:

- log in to your account and contact our customer services team via your self-serve portal [betterbathrooms.com/CustomerAccount/Login](https://www.betterbathrooms.com/CustomerAccount/Login).
- contact us via [betterbathrooms.com/content/contact-us](https://www.betterbathrooms.com/content/contact-us).

## Important information

- Please read these instructions thoroughly and retain for future reference.
- All installation work must be carried out to comply by a qualified installer.
- Always check pressure compatibility, check website for min/max pressure of product.
- Pressures to hot and cold supplies should be balanced for optimum performance.
- All installation work must be carried out to comply with the Water Bylaw Regulations.
- Isolation valves should be fitted to both supply pipes as part of the installation
- System must be flushed through prior to installation.

## Flow Rates

Bar	0.1	0.2	0.5	1	1.5	2
L/Min	6.6	9.2	14.2	19.7	24.2	27.9

## Guarantee

- Please check our website for individual product guarantee's.
- Some parts of the product, i.e. cartridge, are covered by a 12-month guarantee.
- Your guarantee can be invalid if the pre-installation checks are not carried out, installation is not carried out as per this guide, and correct maintenance instructions are not followed. Please see our website for T & C's.

## Parts / Diagrams

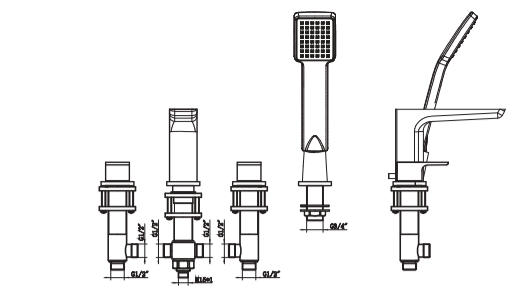
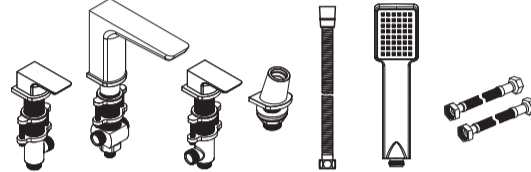

## Installation

1. Drill four holes on the bath as per the drawing shown below.

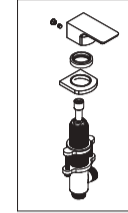
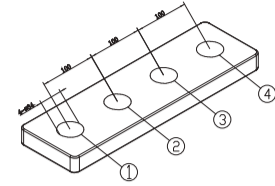

2. Get all the components below ready for hole No. 1.

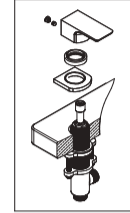

3. Assemble all the components together as shown below.

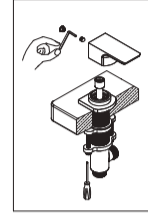

4. Tighten the handle with allen key, tighten the mounting plate with screw driver.

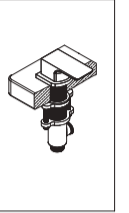

5. Hole No. 1 is installed as per the drawing below.

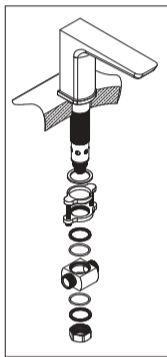

6. Get all the components in place for hole NO. 2.

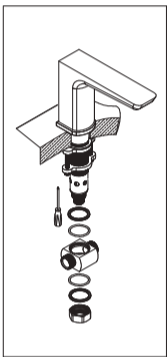

7. Assemble all the components together and tighten the mounting plate with screw driver.

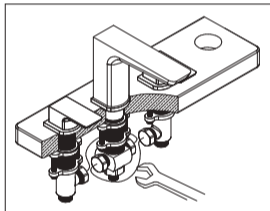

8. Components for holes No. 3 should be installed as per hole No. 1. Tighten all the nuts with spanner.

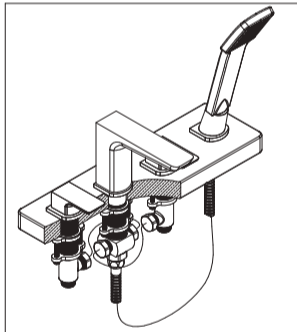

9. Connect shower hose to the mixer outlet and hand shower, ensuring to fit the seals.

## IMPORTANT:

When installing the tail threads, it should be done in such a way to prevent kinks, flat spots and excessive bends, which will affect performance and can potentially cause long term damage and leaks.

No bend in the tail should be less than 25mm radius.



Cold tap section with the handle indicated by C should be on the right and connected to the cold water supply.

## Trouble shooting

Mixer drips after being turned off

1. Draining - due to the design of some mixer spouts, water will be held and drip until emptied.

2. Debris inside the valve - remove the valve and flush under running water while turning the spindle.

Poor water flow

1. Insufficient water pressure - increase water pressure and possibly install a pump.

2. System pressure should meet minimum requirement pre-installation.

3. Blockage - check water is reaching the mixer, check valve, mixer tails and supply pipes.

4. Isolation valves not fully opened.

Water not mixing

1. Hot and Cold supplies not balanced - increase or decrease pressures to balance. (Always maintain the minimum pressure requirement)

2. Blockage / Check water is reaching the mixer, check valve, mixer tails and supply pipes.

## OPERATION

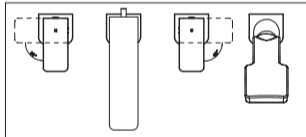

The product operation is shown in the figure above.

## Maintenance

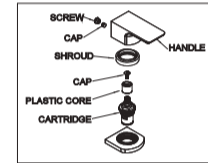

1. Turn off the water supply.
2. Remove screw cap cover at back of handle.
3. Loosen grub screw using a hex key.
4. Pull handle from the mixer.
5. Unscrew cartridge shroud.
6. Using a spanner remove cartridge nut.
7. Pull the cartridge from the mixer.
8. Carry out maintenance.

9. Replace cartridge ensuring to locate pins on the underside of the cartridge with holes inside the mixer.
10. Replace all components (do not overtighten cartridge nut).

## CLEANING

To maintain the surface of your product, wipe with a clean damp cloth and wipe dry. Do not use abrasive cleaning agents or materials which can strip and scratch the surface; the use of these agents or materials can invalidate your guarantee. It is recommended to wipe and dry on a regular basis.

## For more information

- visit [betterbathrooms.com](https://www.betterbathrooms.com)
- email [customerservices@buyitdirect.co.uk](mailto:customerservices@buyitdirect.co.uk)
- call 03303903062
- write to Trident Business Park, Neptune Way, Huddersfield, HD2 1UA. Part of the BuyItDirect Group

better  
bathrooms